

2-Line un-directional TVS Diode Array

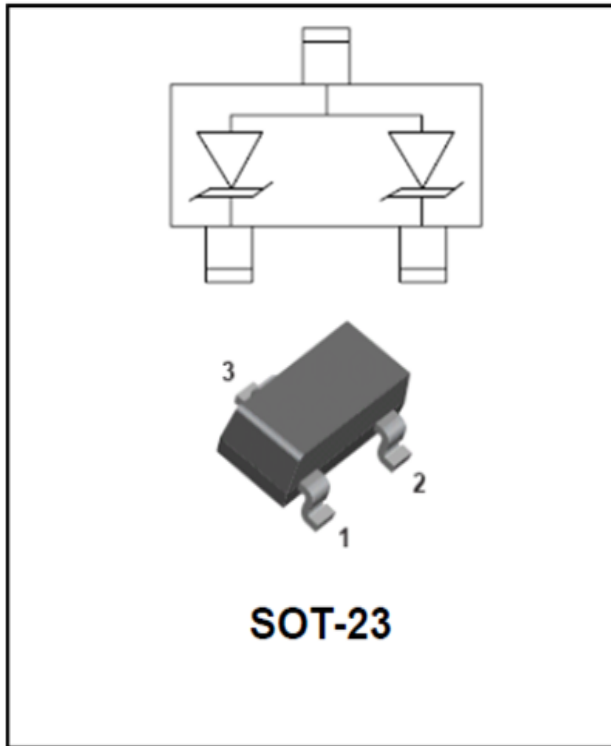

Features

- 270W peak pulse power (8/20 μ s)
- Protects two un-directional lines
- Ultra low leakage: nA level
- Operating voltage: 24V
- Low clamping voltage
- RoHS Compliant

Mechanical Characteristics

- Package: SOT-23
- Lead Finish: Matte Tin
- Case Material: "Green" Molding Compound.
- Moisture Sensitivity: Level 1 per J-STD-020
- Marking Information: See Below

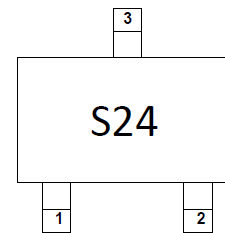

■ Absolute Maximum Ratings (Ta=25°C unless otherwise specified)

PARAMETER	SYMBOL	VALUE	UNIT
Operating Temperature Range	T _J	-55 to +125	°C
Storage Temperature Range	T _{STG}	-55 to +150	°C
ESD per IEC 61000-4-2 (Air)	V _{ESD}	±30	KV
ESD per IEC 61000-4-2 (Contact)		±30	KV
Peak Pulse Power(8/20 μ s)	P _{Pk}	270	W
Peak Pulse Current(8/20 μ s)	I _{PP}	6	A



ASM24

■ Electrical Characteristics (T_a=25°C Unless otherwise specified)

PARAMETER	Symbol	UNIT	Conditions	Min	Typ	Max
Reverse Working Voltage	V _{RWM}	V				24
Reverse Leakage Current	I _R	uA	V _{RWM} =24V			0.2
Breakdown Voltage	V _(BR)	V	I _T =1mA	27		
Forward Voltage	V _F	V	I _F =10mA		0.8	1.2
Clamping Voltage	V _C ⁽¹⁾	V	I _{PP} =1A (8 x 20μs pulse)			32
Clamping Voltage	V _C	V	I _{PP} =6A(8 x 20μs pulse)			45
Junction Capacitance	C _J	pF	V _R =0V, f=1MHz Pin 1 to Pin 3 or Pin 2 to Pin 3			40
Junction Capacitance	C _J	pF	V _R =0V, f=1MHz Pin 1 to Pin 2			20

■ Thermal Characteristics (T_a=25°C Unless otherwise specified)

PARAMETER	SYMBOL	UNIT	ASM24
Thermal Resistance(Typical)	R _{θJ-A}	°C/W	357
	R _{θJ-C}	°C/W	143

■ Characteristics (Typical)

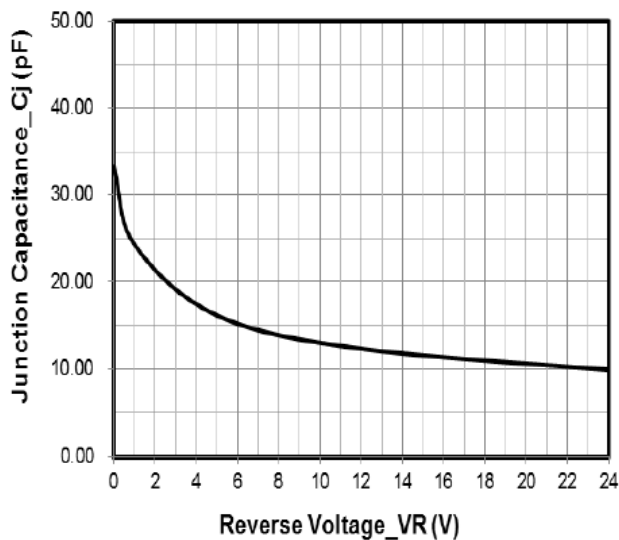

Junction Capacitance vs. Reverse Voltage

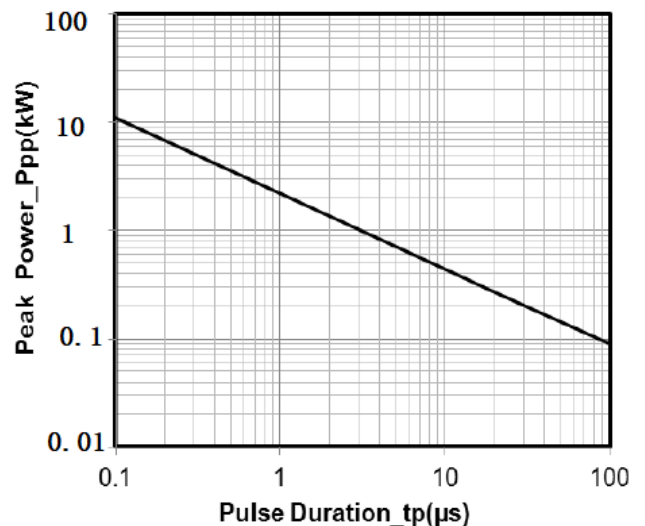

Peak Pulse Power vs. Pulse Time



ASM24

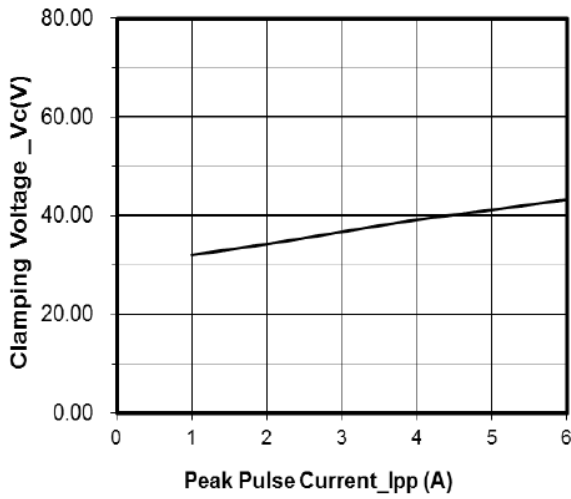

Clamping Voltage vs. Peak Pulse Current

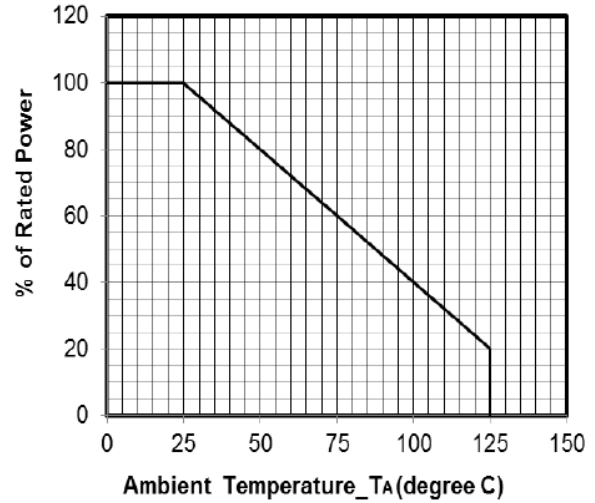

Power Derating Curve

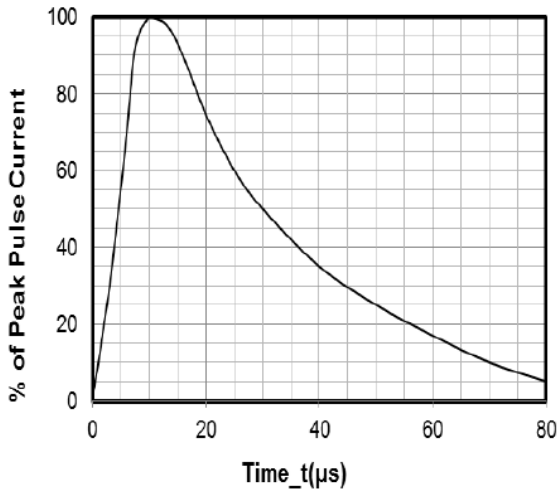

8 X 20μs Pulse Waveform

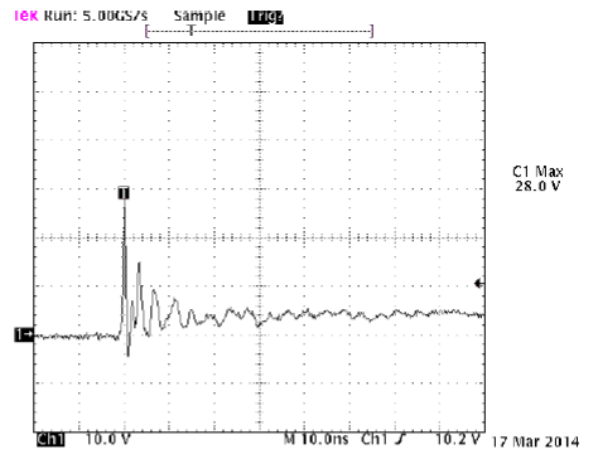

Note: Data is taken with a 10x attenuator

ESD Clamping Voltage
8 kV Contact per IEC61000-4-2

■ Outline Dimensions

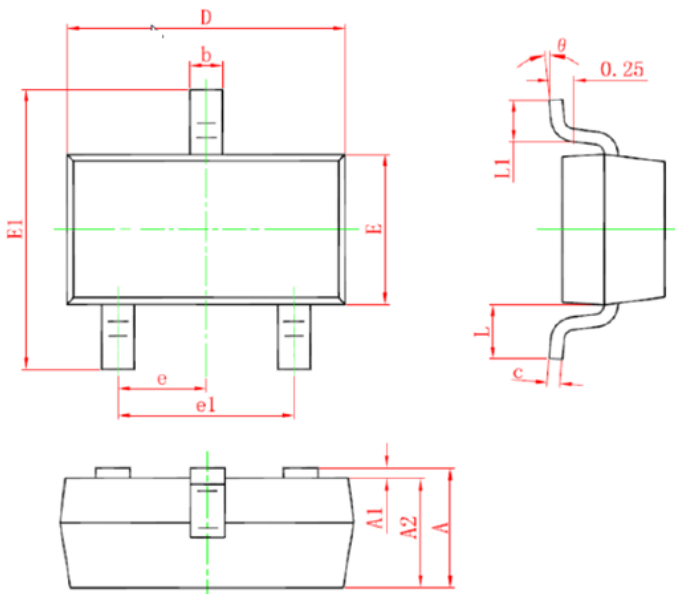

SYM	DIMENSIONS					
	MILLIMETERS			INCHES		
	MIN	NOM	MAX	MIN	NOM	MAX
A	0.90	--	1.15	0.035	--	0.045
A1	0.00	--	0.10	0.000	--	0.004
A2	0.90	--	1.05	0.035	--	0.041
b	0.30	--	0.50	0.012	--	0.020
c	0.08	--	0.15	0.003	--	0.006
D	2.80	--	3.00	0.110	--	0.118
E	1.20	--	1.40	0.047	--	0.055
E1	2.25	--	2.55	0.089	--	0.100
e	0.95TYP			0.037TYP		
e1	1.80	--	2.00	0.071	--	0.079
L	0.55REF			0.022REF		
L1	0.30	--	0.50	0.012	--	0.020
θ	0°	--	8°	0°	--	8°



ASM24

■ Soldering Footprint

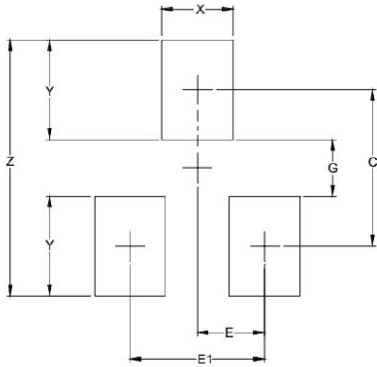

SYM	DIMENSIONS	
	INCHES	MILLIMETERS
C	.087	2.20
E	.037	0.95
E1	.075	1.90
G	.031	0.80
X	.039	1.00
Y	.055	1.40
Z	.141	3.60



ASM24

Disclaimer

The information presented in this document is for reference only. Yangzhou Yangjie Electronic Technology Co., Ltd. reserves the right to make changes without notice for the specification of the products displayed herein to improve reliability, function or design or otherwise.

The product listed herein is designed to be used with ordinary electronic equipment or devices, and not designed to be used with equipment or devices which require high level of reliability and the malfunction of which would directly endanger human life (such as medical instruments, transportation equipment, aerospace machinery, nuclear-reactor controllers, fuel controllers and other safety devices), Yangjie or anyone on its behalf, assumes no responsibility or liability for any damages resulting from such improper use of sale.

This publication supersedes & replaces all information previously supplied. For additional information, please visit our website [http:// www.21yangjie.com](http://www.21yangjie.com) , or consult your nearest Yangjie's sales office for further assistance.