

## N-Channel Enhancement Mode Field Effect Transistor

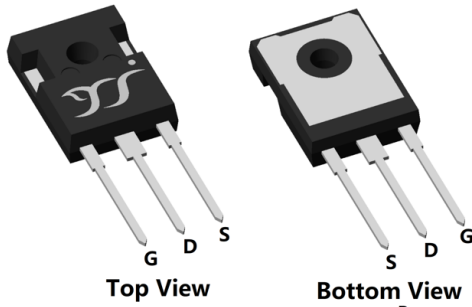

**TO-247**

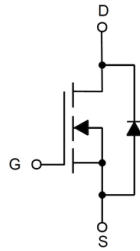

### Product Summary

- $V_{DS}$  600V
- $I_D$  33A
- $R_{DS(ON)}$  (at  $V_{GS}=10V$ )  $<72m\Omega$
- 100% EAS Tested
- 100%  $\nabla V_{DS}$  Tested

### General Description

- Excellent package for heat dissipation
- High density cell design for low  $R_{DS(ON)}$
- Epoxy Meets UL 94 V-0 Flammability Rating
- Halogen Free

### Applications

- EV Charger
- AC-DC Power Management
- Sever/Telecom/PC Power

### ■ Absolute Maximum Ratings ( $T_J=25^\circ C$ unless otherwise noted)

Parameter			Symbol	Limit	Unit	
Drain-source Voltage			$V_{DS}$	600	V	
Gate-source Voltage			$V_{GS}$	$\pm 30$	V	
Continuous Drain Current (Note 1,2)	Steady-State	$T_A=25^\circ C$	$I_D$	3.9	A	
		$T_A=100^\circ C$		2.4		
Continuous Drain Current (Note 1,3)	Steady-State	$T_C=25^\circ C$		33		
		$T_C=100^\circ C$		20		
Pulsed Drain Current	$T_C=25^\circ C, t_p=100\mu s$		$I_{DM}$	110	A	
Avalanche energy			$V_G=10V, R_G=25\Omega, L=30mH, I_{AS}=7.7A$	EAS	889.35	mJ
Total Power Dissipation (Note 1,2)	Steady-State	$T_A=25^\circ C$	$P_D$	3.1	W	
		$T_A=100^\circ C$		1.2		
Total Power Dissipation (Note 1,3)	Steady-State	$T_C=25^\circ C$		227		
		$T_C=100^\circ C$		90		
Junction and Storage Temperature Range			$T_J, T_{STG}$	-55~+150	$^\circ C$	

### ■ Thermal resistance

Parameter		Symbol	Typ	Max	Units
Thermal Resistance Junction-to-Ambient (Note 2)	Steady-State	$R_{\theta JA}$	35	40	$^\circ C/W$
Thermal Resistance Junction-to-Case	Steady-State	$R_{\theta JC}$	0.45	0.55	

### ■ Ordering Information (Example)

PREFERRED P/N	PACKING CODE	Marking	MINIMUM PACKAGE(pcs)	INNER BOX QUANTITY(pcs)	OUTER CARTON QUANTITY(pcs)	DELIVERY MODE
YJN48C60HJ	B1	YJN48C60HJ	30	360	1800	Tube



# YJN48C60HJ

## ■ Electrical Characteristics (T<sub>J</sub>=25°C unless otherwise noted)

Parameter	Symbol	Conditions	Min	Typ	Max	Units
<b>Static Parameter</b>						
Drain-Source Breakdown Voltage	BV <sub>DSS</sub>	V <sub>GS</sub> =0V, I <sub>D</sub> =250μA	600	-	-	V
		V <sub>GS</sub> =0V, I <sub>D</sub> =10mA	600	-	-	V
Zero Gate Voltage Drain Current	I <sub>DSS</sub>	V <sub>DS</sub> =600V, V <sub>GS</sub> =0V	-	-	10	μA
Gate-Body Leakage Current	I <sub>GSS</sub>	V <sub>GS</sub> =±30V, V <sub>DS</sub> =0V	-	-	±100	nA
Gate Threshold Voltage	V <sub>GS(th)</sub>	V <sub>DS</sub> =V <sub>GS</sub> , I <sub>D</sub> =250μA	3	4	5	V
Static Drain-Source On-Resistance	R <sub>DS(on)</sub>	V <sub>GS</sub> =10V, I <sub>D</sub> =24A	-	60	72	mΩ
Diode Forward Voltage	V <sub>SD</sub>	I <sub>S</sub> =24A, V <sub>GS</sub> =0V	-	-	1.2	V
Gate resistance	R <sub>G</sub>	f=1MHz	-	2.2	-	Ω
Maximum Body-Diode Continuous Current	I <sub>S</sub>		-	-	33	A
<b>Dynamic Parameters</b>						
Input Capacitance	C <sub>iss</sub>	V <sub>DS</sub> =300V, V <sub>GS</sub> =0V, f=1MHz	-	3480	-	pF
Output Capacitance	C <sub>oss</sub>		-	108	-	
Reverse Transfer Capacitance	C <sub>rss</sub>		-	22.4	-	
<b>Switching Parameters</b>						
Total Gate Charge	Q <sub>g</sub>	V <sub>GS</sub> =10V, V <sub>DS</sub> =300V, I <sub>D</sub> =24A	-	70	-	nC
Gate-Source Charge	Q <sub>gs</sub>		-	21.8	-	
Gate-Drain Charge	Q <sub>gd</sub>		-	29.6	-	
Reverse Recovery Charge	Q <sub>rr</sub>	I <sub>F</sub> =24A, di/dt=100A/us	-	1430	-	nC
Reverse Recovery Time	t <sub>rr</sub>		-	157	-	ns
Turn-on Delay Time	t <sub>D(on)</sub>	V <sub>GS</sub> =10V, V <sub>DD</sub> =300V, I <sub>D</sub> =24A R <sub>GEN</sub> =3Ω	-	64	-	ns
Turn-on Rise Time	t <sub>r</sub>		-	18.5	-	
Turn-off Delay Time	t <sub>D(off)</sub>		-	41.5	-	
Turn-off fall Time	t <sub>f</sub>		-	6	-	

Note:

1. The entire application environment impacts the thermal resistance values shown, they are not constants and are only valid for the particular conditions noted.
2. The value of R<sub>θJA</sub> is measured in the still air environment with TA =25°C. The maximum allowed junction temperature of 150°C.
3. Thermal resistance from junction to soldering point (on the exposed drain pad).



## Typical Electrical and Thermal Characteristics Diagrams

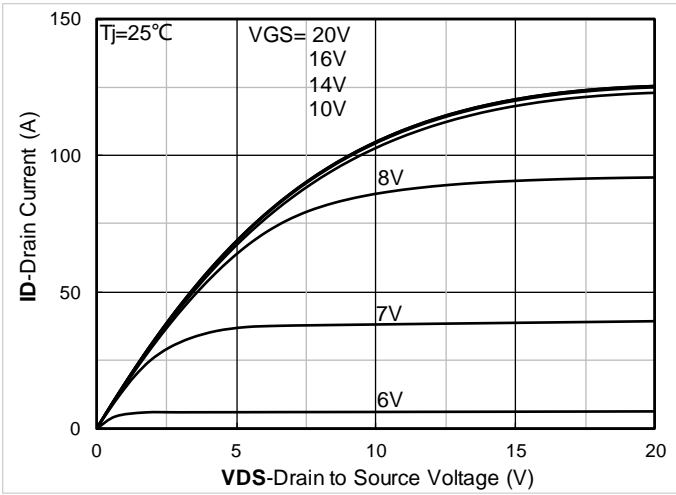

Figure 1. Output Characteristics

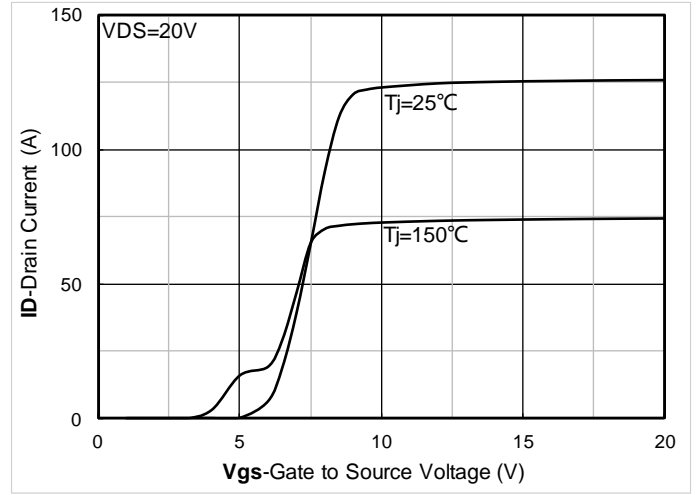

Figure 2. Transfer Characteristics

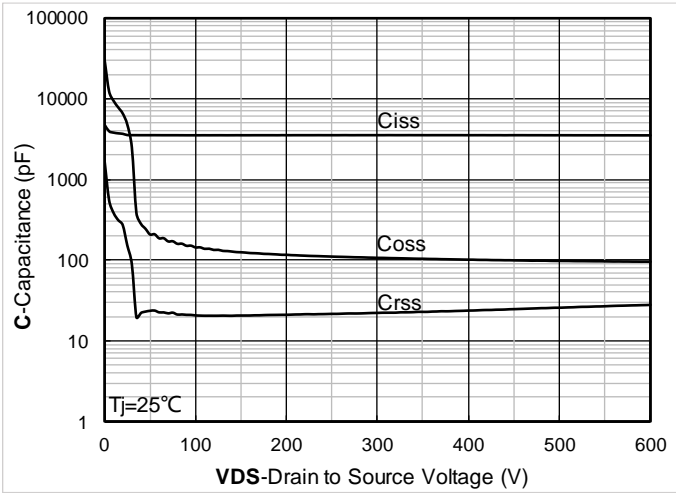

Figure 3. Capacitance Characteristics

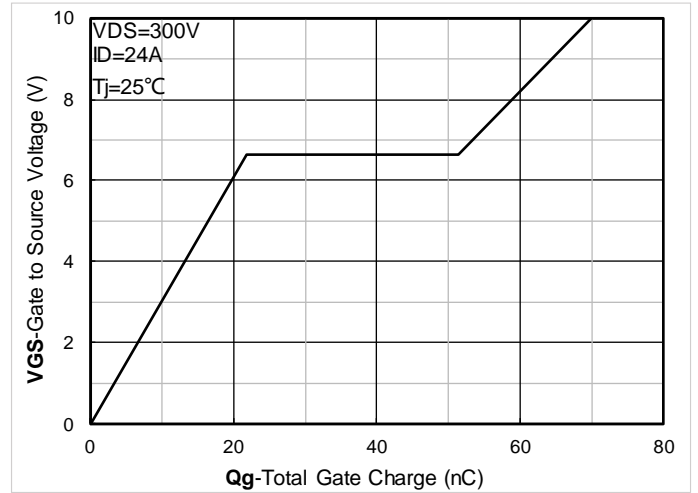

Figure 4. Gate Charge

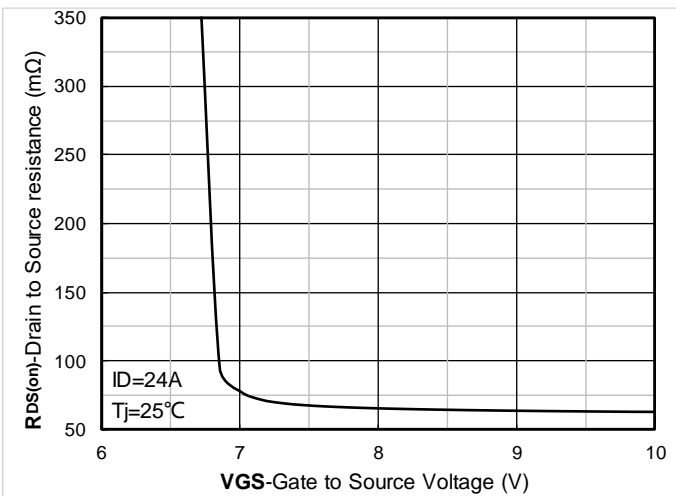

Figure 5. On-Resistance vs Gate to Source Voltage

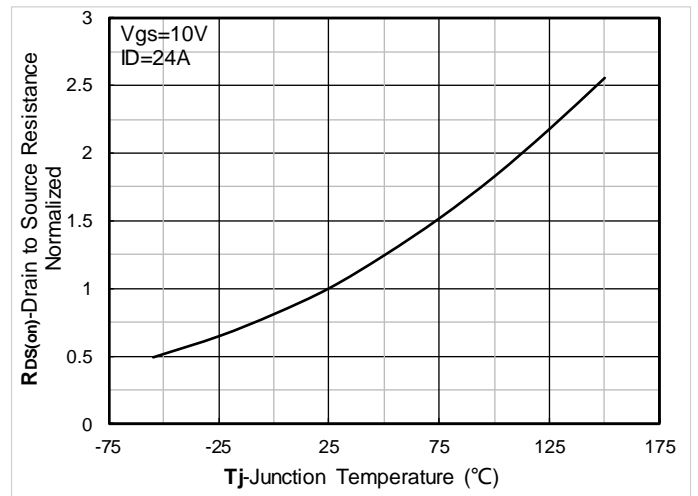

Figure 6. Normalized On-Resistance



# YJN48C60HJ

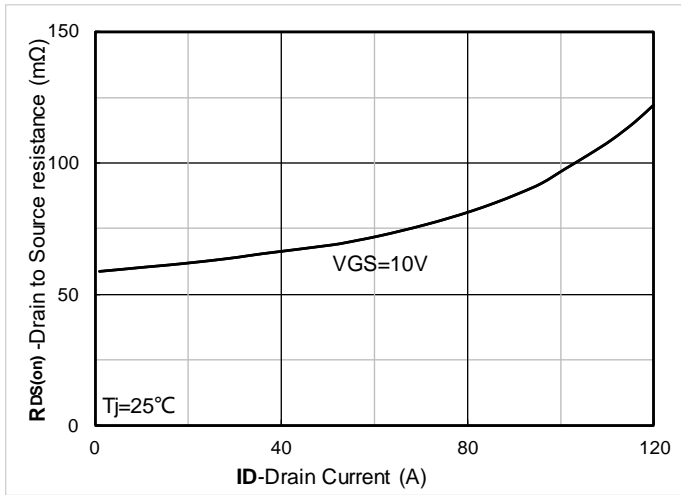

Figure 7. RDS(on) VS Drain Current

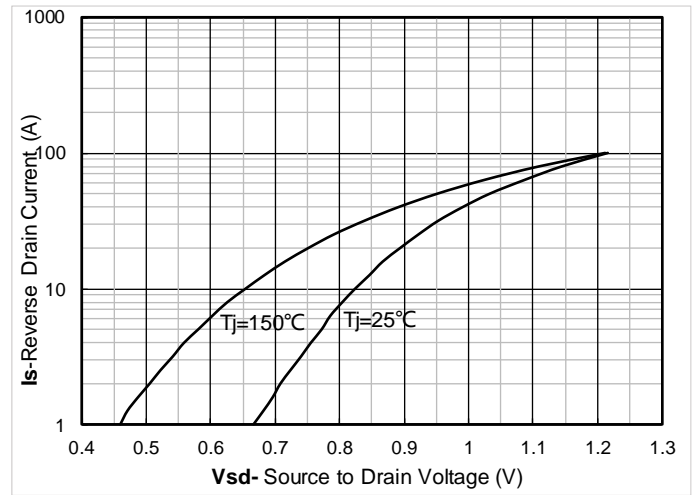

Figure 8. Forward characteristics of reverse diode

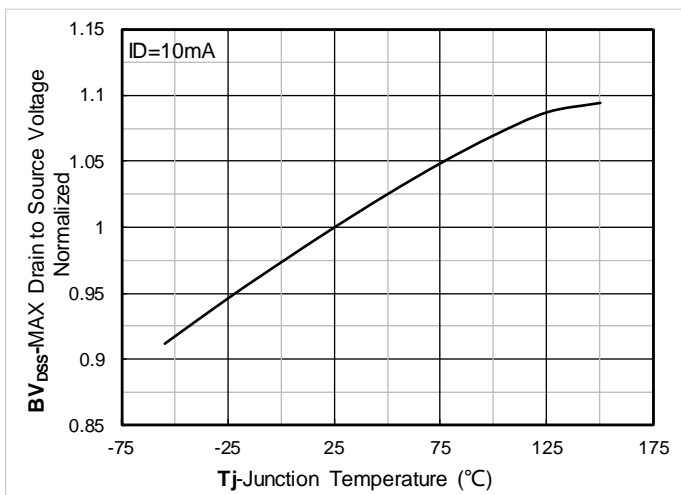

Figure 9. Normalized breakdown voltage

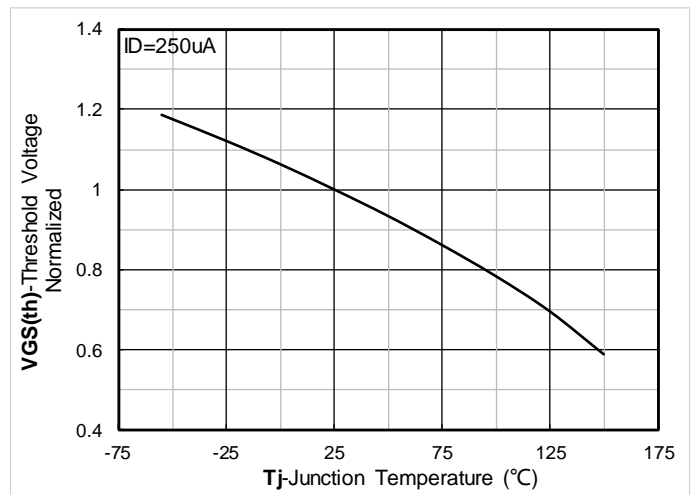

Figure 10. Normalized Threshold voltage

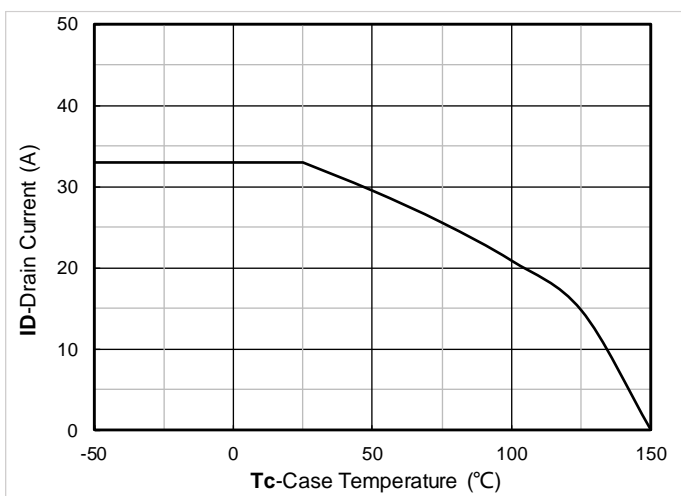

Figure 11. Current dissipation

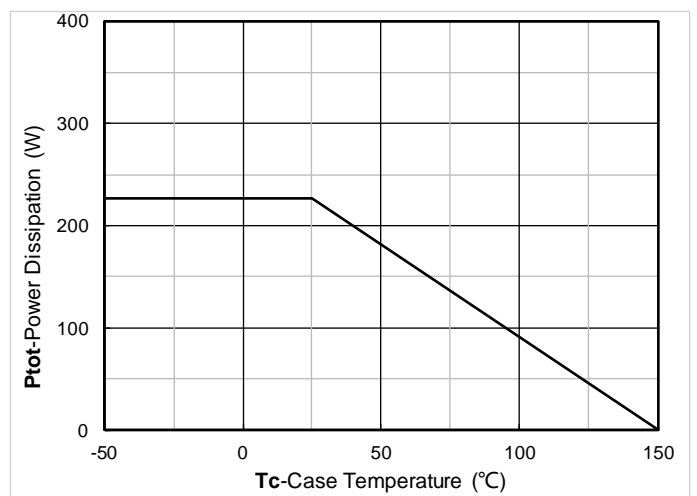

Figure 12. Power dissipation

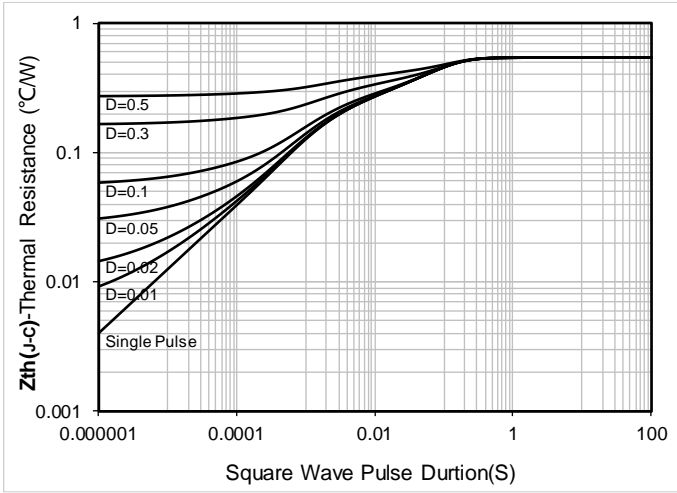

Figure 13. Maximum Transient Thermal Impedance

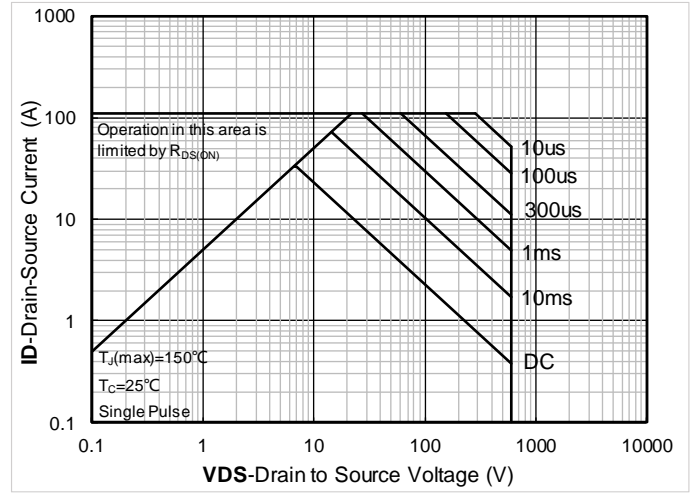

Figure 14. Safe Operation Area

## ■ Test Circuits & Waveforms

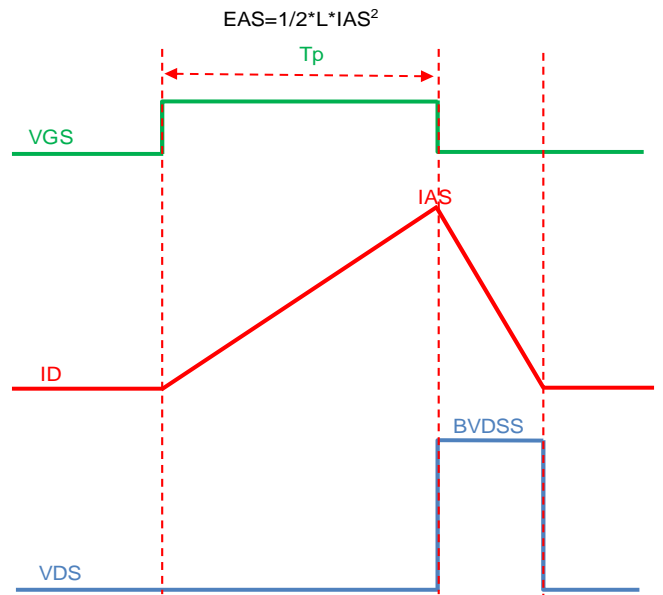
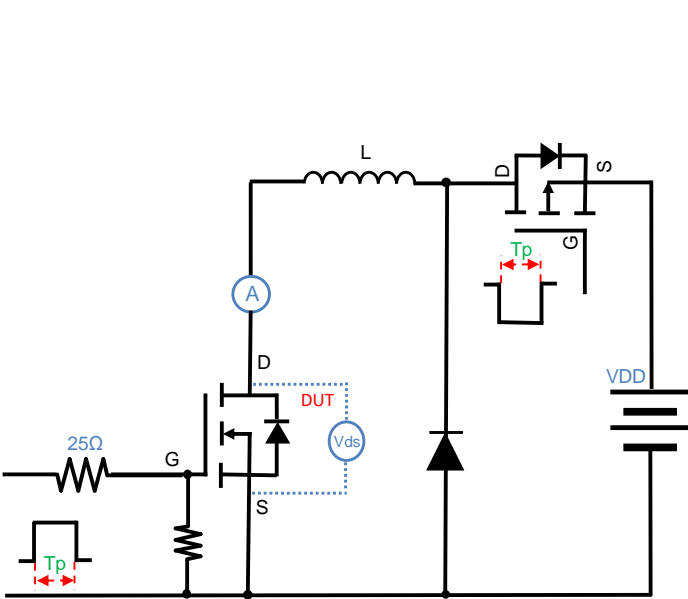

Figure A. Unclamped Inductive Switching (UIS) Test Circuit & Waveform



Figure B. Gate Charge Test Circuit & Waveform



Figure C. Resistive Switching Test Circuit & Waveform



Figure D. Diode Recovery Test Circuit & Waveform

## ■ TO-247AB Package information

**TO-247AB**

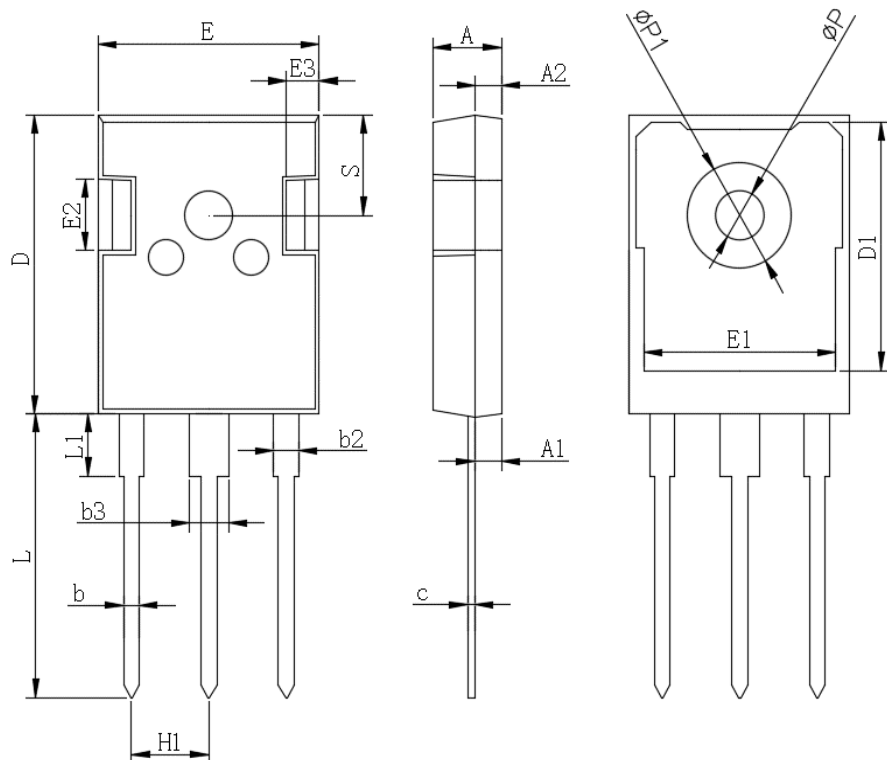

TO-247AB		
Dim	Min	Max
A	4.80	5.20
A1	2.21	2.61
A2	1.85	2.15
b	1.0	1.4
b2	1.91	2.21
c	0.5	0.7
D	20.70	21.30
D1	16.25	16.85
E	15.50	16.10
E1	13.0	13.6
E2	4.80	5.20
E3	2.30	2.70
L	19.62	20.22
L1	-	4.30
$\phi P$	3.40	3.80
$\phi P1$	-	7.30
S	6.15TYP	
H1	5.44TYP	
b3	2.80	3.20



## YJN48C60HJ

---

### Disclaimer

The information presented in this document is for reference only. Yangzhou Yangjie Electronic Technology Co., Ltd. reserves the right to make changes without notice for the specification of the products displayed herein to improve reliability, function or design or otherwise.

The product listed herein is designed to be used with ordinary electronic equipment or devices, and not designed to be used with equipment or devices which require high level of reliability and the malfunction of which would directly endanger human life (such as medical instruments, transportation equipment, aerospace machinery, nuclear-reactor controllers, fuel controllers and other safety devices), Yangjie or anyone on its behalf, assumes no responsibility or liability for any damages resulting from such improper use of sale.

This publication supersedes & replaces all information previously supplied. For additional information, please visit our website <http://www.21yangjie.com> , or consult your nearest Yangjie's sales office for further assistance.